

X4m

LED Video Controller

Specification V1.3



Overview

X4m is a professional LED display control device with powerful video signal source and processing capabilities. It can handle up to 1920×1080 HD digital signals, supports various types of HD digital interfaces, and supports arbitrary zooming and clipping of video sources. In addition, the X4m supports USB flash drive content playback.

X4m has 4 gigabit network port outputs and can support maximum 3840 pixels in width and maximum 2000 pixels in height. At the same time, X4m has a series of practical functions, providing flexible screen control and high-quality image display, which can be perfectly applied to small LED display.

Features

Input

- Input resolution: max 1920×1080@60Hz.
- Signal sources: 2×HDMI1.4, 1×DVI, 1×VGA, 1×CVBS.
- U-disk interface: 1×USB.

Output

- Loading capacity: 2.6 million pixels.
- Maximum width is 3840 pixels or maximum height is 2000 pixels.
- 4 Gigabit Ethernet output ports.
- Supports Ethernet port redundancy

Audio

- Input: 1×3.5mm.
- Output: 1×3.5mm, support HDMI and DP audio outputs.

Function

- Supports switching, clipping and zooming.
- Supports screen offset.
- Supports screen adjustment: contrast, saturation, chroma, brightness compensation and sharpness adjustment.
- Supports convert Limit Range to Full Range input color space.
- Supports send and read back screen correction factor, advanced stitching.
- Supports HDCP1.4.
- Supports Precise Color Management.
- Supports Better Gray Level at Low Brightness, can effectively maintain the complete display of grey scale under low brightness.

- 16 scene presets.
- Play back pictures and videos from U-disk.
- OSD for U-disk playback and screen adjustment (Remote controller optional).

Control

- USB port for control or cascading.
- RS232 protocol control.
- Infrared remote control (optional).

Appearance

Front panel

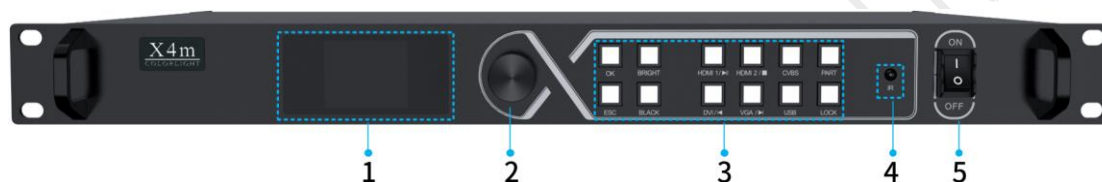

No.	Item	Function
1	LCD display	Display operation menu and system information.
2	Knob	<ul style="list-style-type: none"> • Press the knob to access the submenu or confirm. • Turn the knob to select menu items or adjust parameters.
3	Function button	<ul style="list-style-type: none"> • OK: Enter. • Bright: Adjust brightness. • ESC: Exit the current interface. • Black: Black the screen. • HDMI 1▶▶ / HDMI 2■ / DVI 1◀ / VGA ▶▶ : <ul style="list-style-type: none"> - Switching to a signal source by clicking corresponding button. - In U-disk playback mode, these buttons serve respectively as play/pause, stop, previous and next. • CVBS: Switch to CVBS. • PART: Clip the picture. • USB: Click the USB button to enter the USB disk play mode, click again to exit. • LOCK: Lock the buttons on the front panel.
4	Switch	Switch on/off.

Rear panel

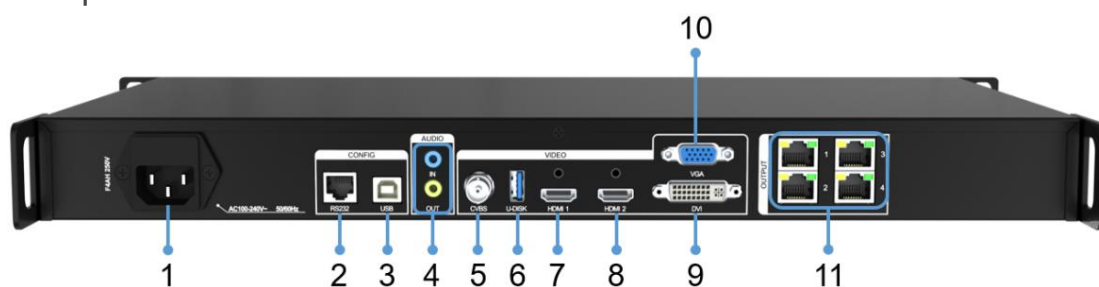

Power supply		
1	Power Socket	AC100-240V~, 50 / 60Hz, Connect to AC power supply.
Control		
2	RS232	RJ11 (6P6C) interface *, used to connect the central control.
3	USB	USB2.0 Type B interface, connect to PC for configuration.
Audio		
4	AUDIO IN	<ul style="list-style-type: none"> Interface type: 3.5mm, Receive audio signals from computer or other equipment.
	AUDIO OUT	<ul style="list-style-type: none"> Interface type: 3.5mm, Support HDMI, DP audio decoding and output audio signals to devices such as active speakers.
Input		
5	CVBS	PAL/NTSC video input
6	U-DISK	<ul style="list-style-type: none"> USB flash drive interface. USB flash drive format supported: NTFS, FAT32, FAT16. Image file formats: jpeg, PNG, webp, BMP. Video codec: MPEG1/2, MPEG4, Sorenson H.263, H.263, H.264(AVC1), H.265(HEVC), RV30/40, Divx, Xvid. Audio codec: MPEG1/2 Layer I, MPEG1/2 Layer II, MPEG1/2 Layer III, AACLC, VORBIS, PCM, and FLAC. Video resolution: maximum 1920×1080@60Hz.
7	HDMI 1	<ul style="list-style-type: none"> 1 x HDMI1.4 input. Maximum resolution: 1920×1080@60Hz. Support EDID1.4. Support HDCP1.4. Support audio input.

8	HDMI 2	<ul style="list-style-type: none"> • 1 x HDMI1.4 input. • Maximum resolution: 1920×1080@60Hz. • Support EDID1.4. • Support HDCP1.4. • Support audio input.
9	DVI	<ul style="list-style-type: none"> • Maximum resolution: 1920×1080@60Hz. • Support EDID1.4. • Support HDCP1.4.
10	VGA	<ul style="list-style-type: none"> • Maximum resolution: 1920×1080@60Hz.
Output		
11	PORT 1-4	<ul style="list-style-type: none"> • 4 Gigabit Ethernet ports. • One network port load capacity: 655360 pixels. • Total load capacity is 2.6 million pixels, maximum width is 3840 pixels and maximum height is 2000 pixels. • It is highly recommended that the cable (CAT5E) length should not exceed 100m. • Support redundant backup.

* RJ11 (6P6C) to DB9 connecting diagram. The cable is optional, please contact Colorlight sales or FAE for the cable.

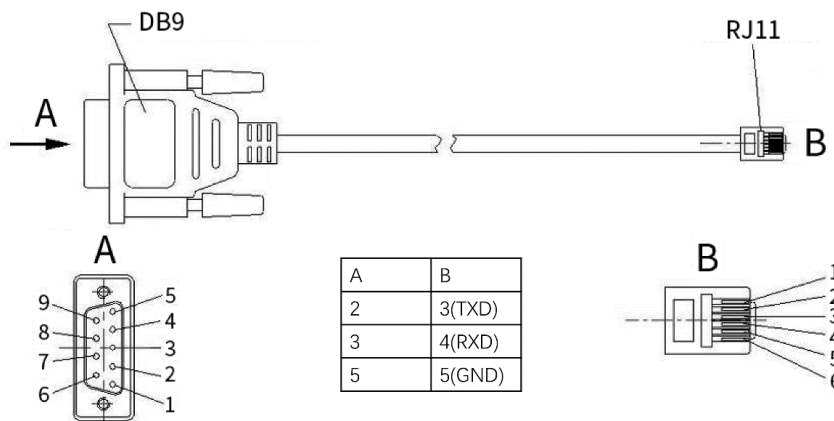

* Remote controller is optional. Please contact Colorlight sales or FAE for the remote controller.

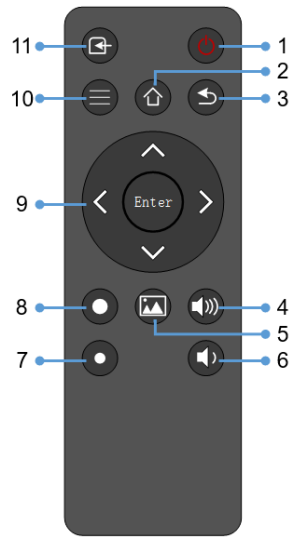

No.	Item	Function
1	Sleep/Wake up	Hibernate/wake up the device (one-button black screen switch)
2	Main menu	Open the OSD menu.
3	Back	Exit the OSD menu or return to previous menu
4	Volume +	Volume up
5	U-disk playback	Playback content from U-disk
6	Volume -	Volume down
7	Bright -	Decrease the screen brightness
8	Bright +	Increase the screen brightness
9	Confirm + directions	Confirm and navigation buttons
10	Menu	Switch on/off the menu
11	Input signal sources	Switch input signal sources

Application scenarios

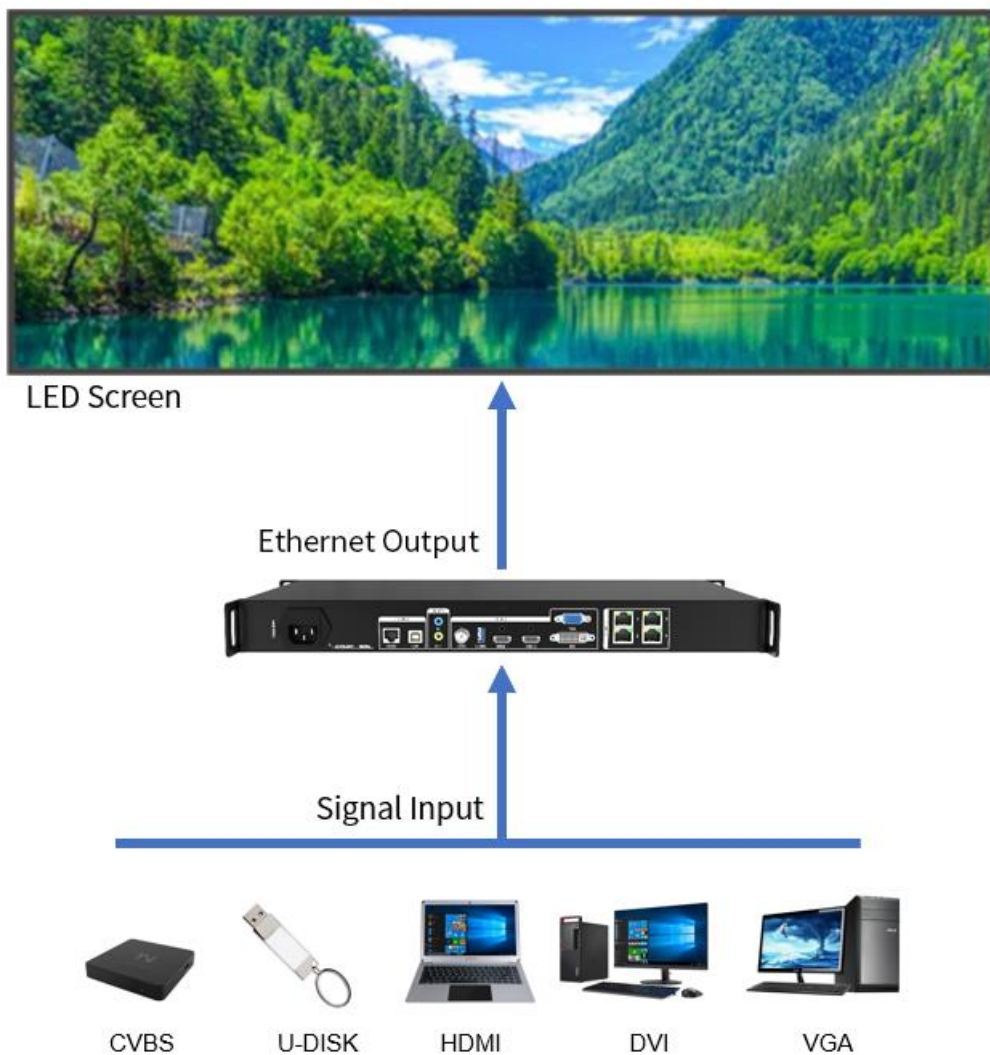

Signal format

Input	Color space	Sampling	Color depth	Max Resolution	Frame rate
DVI	RGB	4:4:4	8bit	1920×1080@60Hz	23.98, 24, 25, 29.97, 30, 50, 59.94, 60
HDMI 1.4	YCbCr	4:2:2	8bit	1920×1080@60Hz	23.98, 24, 25, 29.97,
	YCbCr	4:4:4	8bit		30, 50, 59.94, 60 ,
	RGB	4:4:4	8bit		100, 120

Other specification

Chassis size (W×H×D)	
Host	482.6mm (19.0") × 44.0mm (1.7") × 292.0mm (11.5")
Package	523.0mm (20.6") × 95.0mm (3.7") × 340.0mm (13.4")
Weight	
Net weight	3.13kg (6.90lbs)
Gross weight	4.16kg (9.17lbs)
Electrical Characteristics	
Input power	AC100-240V, 50/60Hz
Power rating	10W
Work condition	
Temperature	-20°C~65°C (-4°F~149°F)
Humidity	0%RH~80%RH, no condensation
Storage condition	
Temperature	-30°C~80°C (-22°F~176°F)
Humidity	0%RH~90%RH, no condensation
Software version	
LEDVISION	V8.5 or above.
iSet	V6.0 or above.
LEDUpgrade	V3.9 or above.
Certification	
CCC, FCC, CE, UKCA.	
* If the product does not have the relevant certifications required by the countries or regions where it is to be sold, please contact Colorlight to confirm or address the problem. Otherwise, the customer shall be responsible for the legal risks caused or Colorlight has the right to claim compensation.	

Reference dimensions

Unit: mm

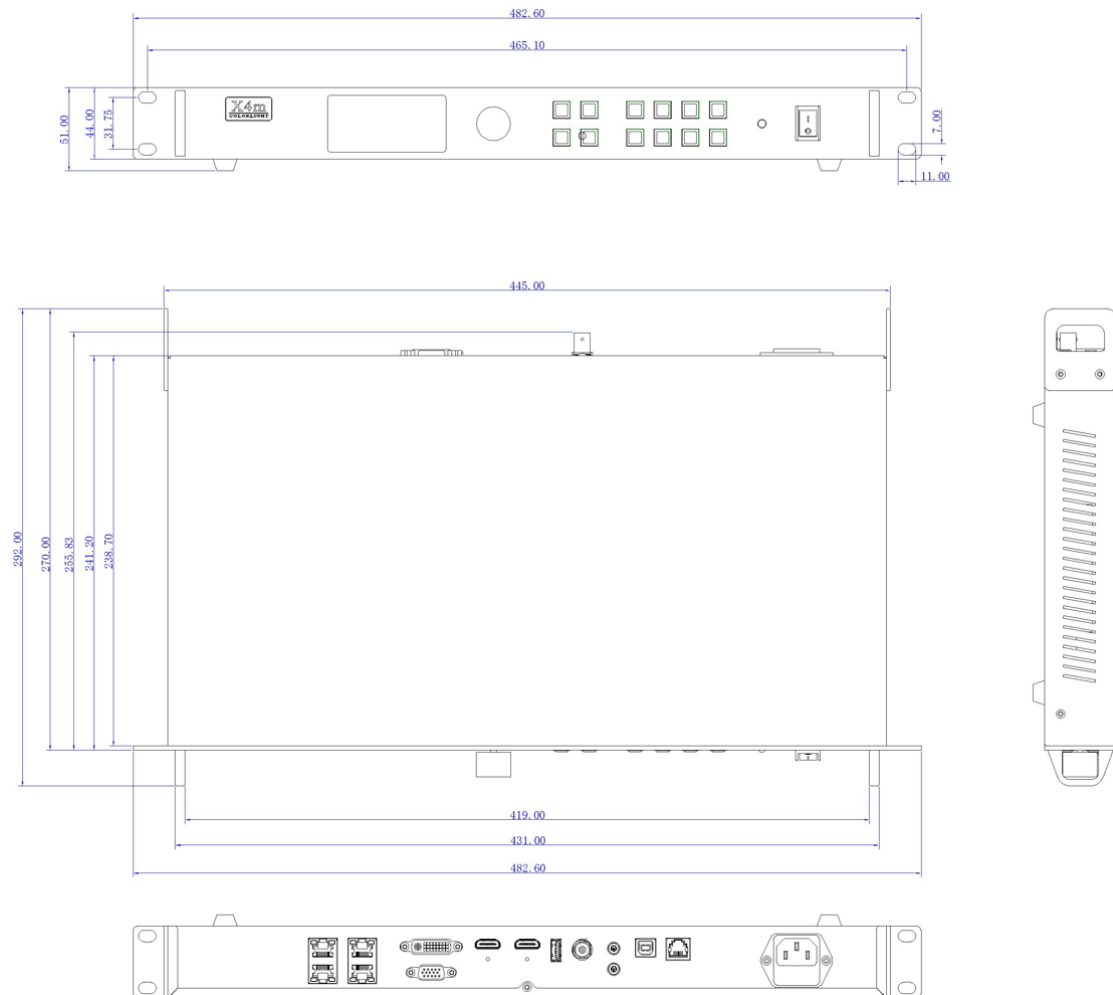

Statement

Copyright © 2022 Colorlight Cloud Tech Ltd. . All rights reserved.

Without the express written permission of Colorlight Cloud Technology Co., Ltd., no unit or individual may copy, copy, transcribe or translate part or all of the contents of this book. Not to be used for any commercial or profit-making purposes in any form or by any means.

 **Colorlight**® logo is a registered trademark of Colorlight Cloud Technology Co., Ltd.

Without the written permission of the company or the trademark owner, no unit or individual may in any way or for any reason use, reproduce, modify, disseminate, transcribe or infringe all or any part of the above-mentioned trademark, nor may it be bundled with other products selling.

As factors such as product batches and production processes may change, in order to provide accurate product information, specification parameters, and product characteristics in order to match the actual product, the text description and picture effects in the document will be appropriately adjusted and revised. If it is necessary to carry out the above modification and adjustment without prior notice, please refer to the actual product.

Thank you for purchasing the product of Colorlight Cloud Tech Ltd. If you encounter any problems during use or have any suggestions, please contact us through official channels. We will do our best to provide support and listen to your valuable suggestions. You can visit www.colorlightinside.com to get more updated information.

Service Phone

4008 770 775

Colorlight Cloud Technology Co., LTD

Official Website: www.colorlightinside.com
Head Office Address: Room 37F-39F, Building 8, Zone A,
Shenzhen International Innovation Valley, Vanke Cloud City, Dashi Yilu,
Nanshan District, Shenzhen, China

